

Wir bitten um schnellmögliche Prüfung der Zeichnung, da ihr Auftrag ohne diese Freigabe nicht weiter bearbeitet werden kann.

Freigegeben durch (Druckbuchstaben):

Datum:

Unterschrift:

Untoleranced dimensions EN ISO 2768 - mk	Designed by:	Name	Date	Item name: Freigabezeichnung Arcelor
	Drawn by:	grunden	26.04.2022	
Tol. with ISO 8015		grunden	26.04.2022	Drawing no: 520104557_11
Projection: ISO E	KEMPER			Scale: 1 : 33
	Kemper GmbH · Von-Siemens-Str. 20 · D-48691 Vreden Tel. +49(0)2564/68-0 · Fax +49(0)2564/68-120 www.kemper.eu · mail@kemper.eu			List/Sheet 1 / 6
We retain the copyrights to this drawing and all other parts. It is either not allowed to reproduce the parts or the drawing without our approval or give third parties access. It also may not be misused in any way by the recipient or third party. Protection mark acc. to DIN ISO 16016.				Format A2

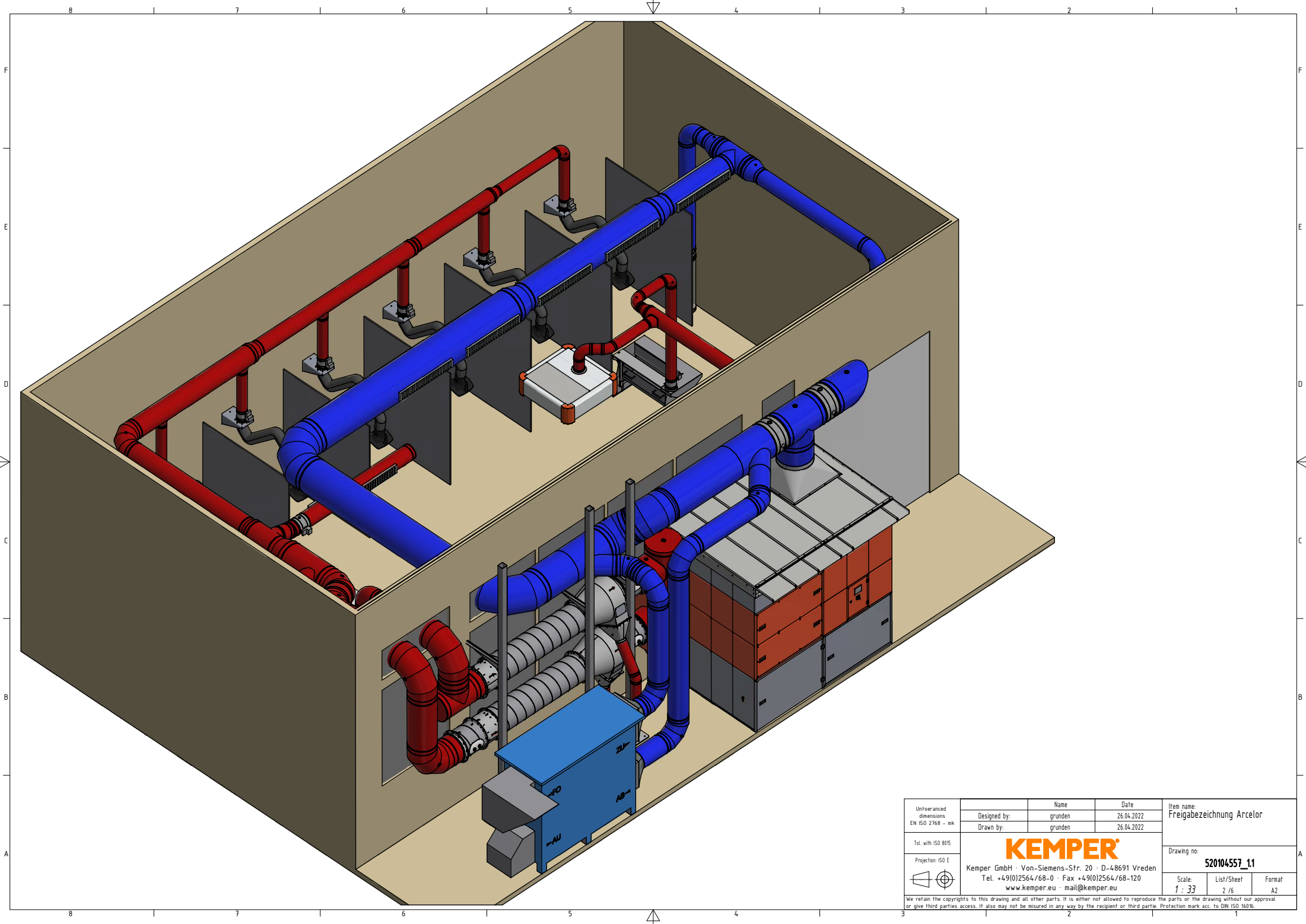

Untoleranced dimensions EN ISO 2768 - mk	Designed by:	grunden	Date	26.04.2022	Item name: Freigabezeichnung Arcelor	
	Drawn by:	grunden	Date	26.04.2022		
Tol. with ISO 8015	 Kemper GmbH · Von-Siemens-Str. 20 · D-48691 Vreden Tel. +49(0)2564/68-0 · Fax +49(0)2564/68-120 www.kemper.eu · mail@kemper.eu				Drawing no:	520104557_11
Projection: ISO E					Scale:	1 : 33

We retain the copyrights to this drawing and all other parts. It is either not allowed to reproduce the parts or the drawing without our approval or give third parties access. It also may not be misused in any way by the recipient or third party. Protection mark acc. to DIN ISO 16016.

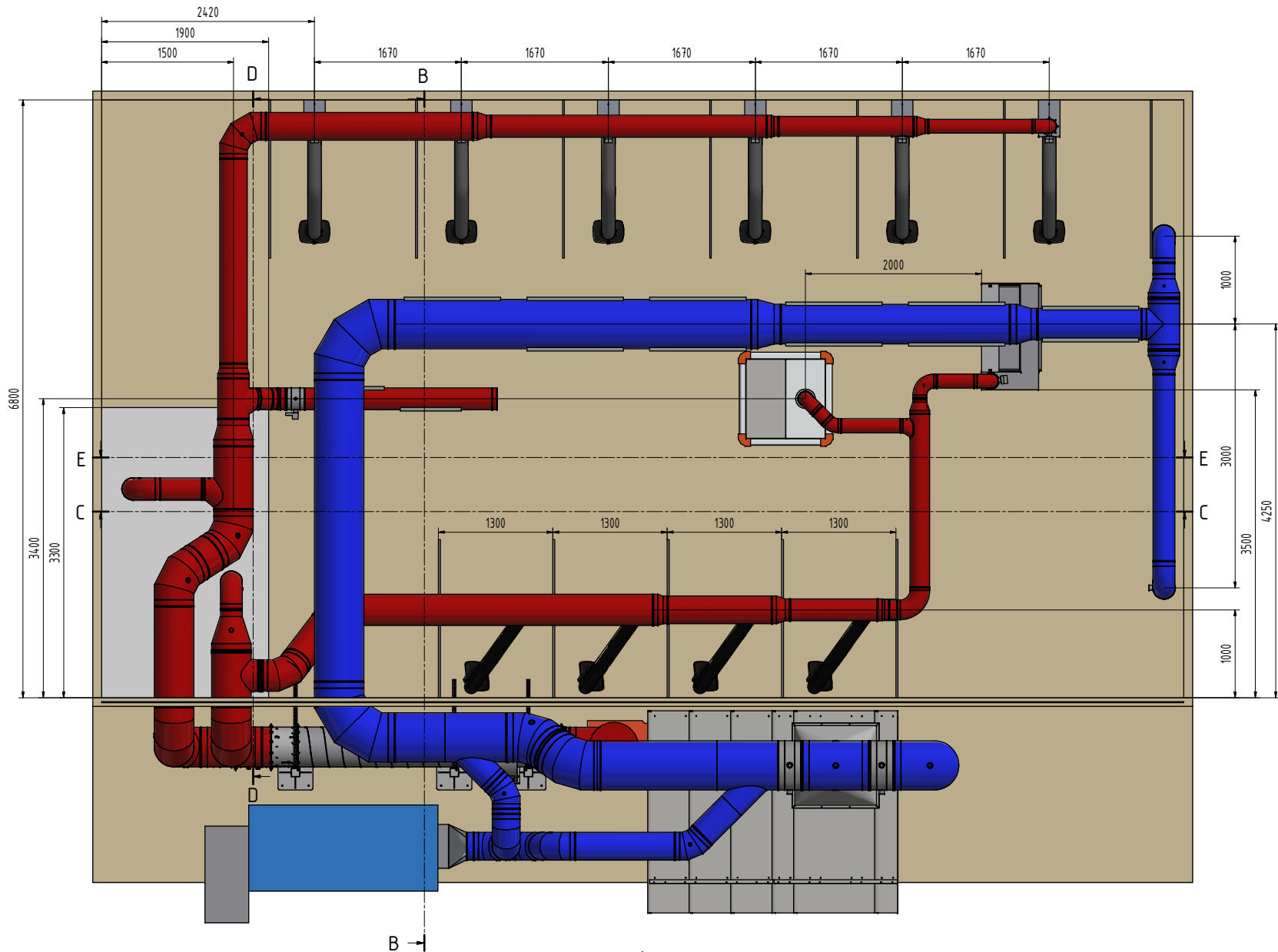

Untoeranced dimensions EN ISO 2768 - mk	Designed by:	grunden	Date	26.04.2022	Item name: Freigabezeichnung Arcelor	
	Drawn by:	grunden	Date	26.04.2022		
Tol. with ISO 8015	 Kemper GmbH · Von-Siemens-Str. 20 · D-48691 Vreden Tel. +49(0)2564/68-0 · Fax +49(0)2564/68-120 www.kemper.eu · mail@kemper.eu				Drawing no:	520104557_11
Projection: ISO E					Scale:	1 : 33

We retain the copyrights to this drawing and all other parts. It is either not allowed to reproduce the parts or the drawing without our approval or give third parties access. It also may not be misured in any way by the recipient or third party. Protection mark acc. to DIN ISO 16016.

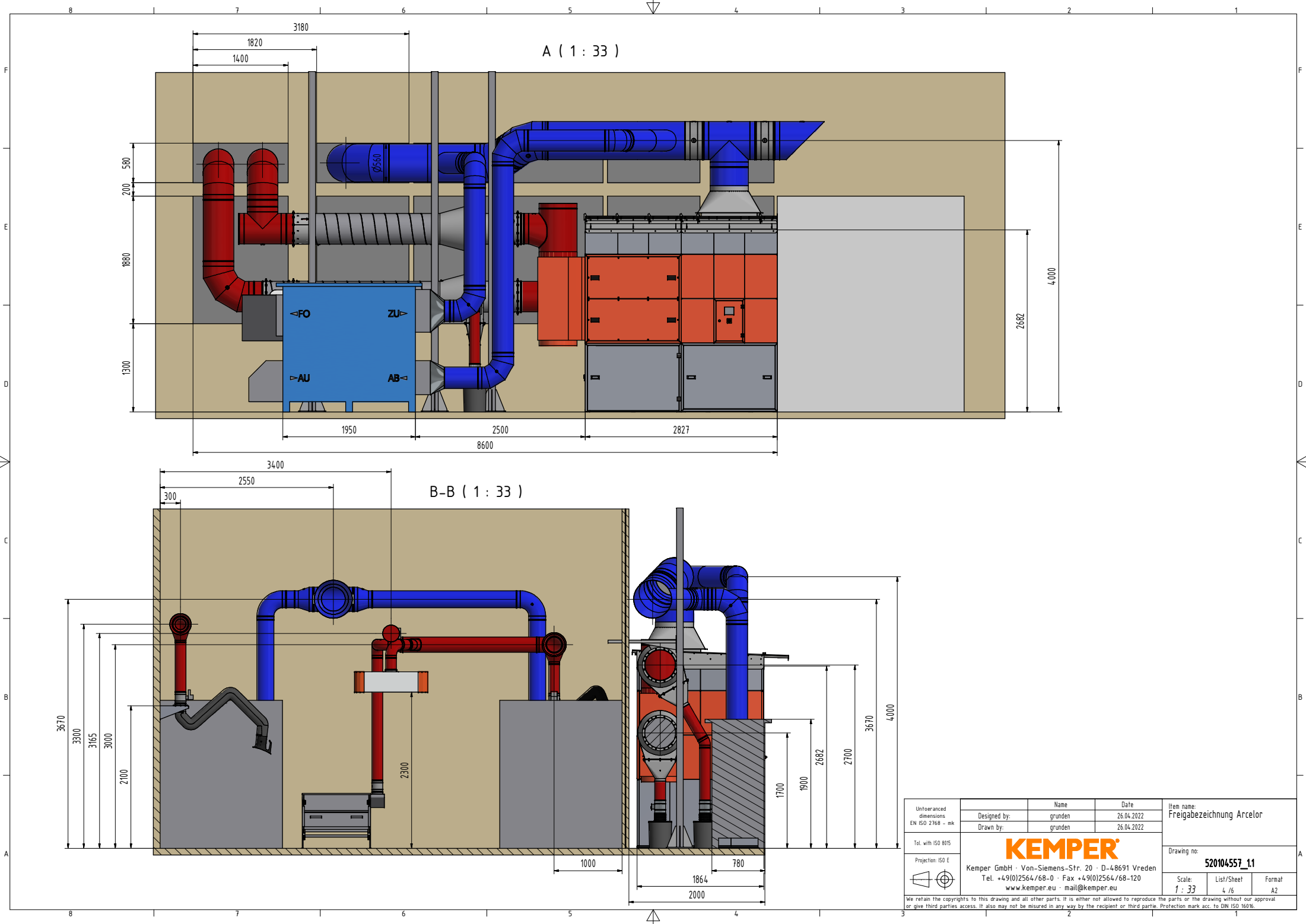

A (1 : 33)

B-B (1 : 33)

Untoeranced dimensions EN ISO 2768 - mk	Designed by:	grunden	Date	26.04.2022	Item name: Freigabezeichnung Arcelor	
	Drawn by:	grunden	Date	26.04.2022		
Tol. with ISO 8015	<p style="text-align: center;">KEMPER</p> Kemper GmbH · Von-Siemens-Str. 20 · D-48691 Vreden Tel. +49(0)2564/68-0 · Fax +49(0)2564/68-120 www.kemper.eu · mail@kemper.eu				Drawing no:	520104557_11
Projection: ISO E					Scale:	1 : 33

We retain the copyrights to this drawing and all other parts. It is either not allowed to reproduce the parts or the drawing without our approval or give third parties access. It also may not be misured in any way by the recipient or third party. Protection mark acc. to DIN ISO 16016.

C-C (1 : 33)

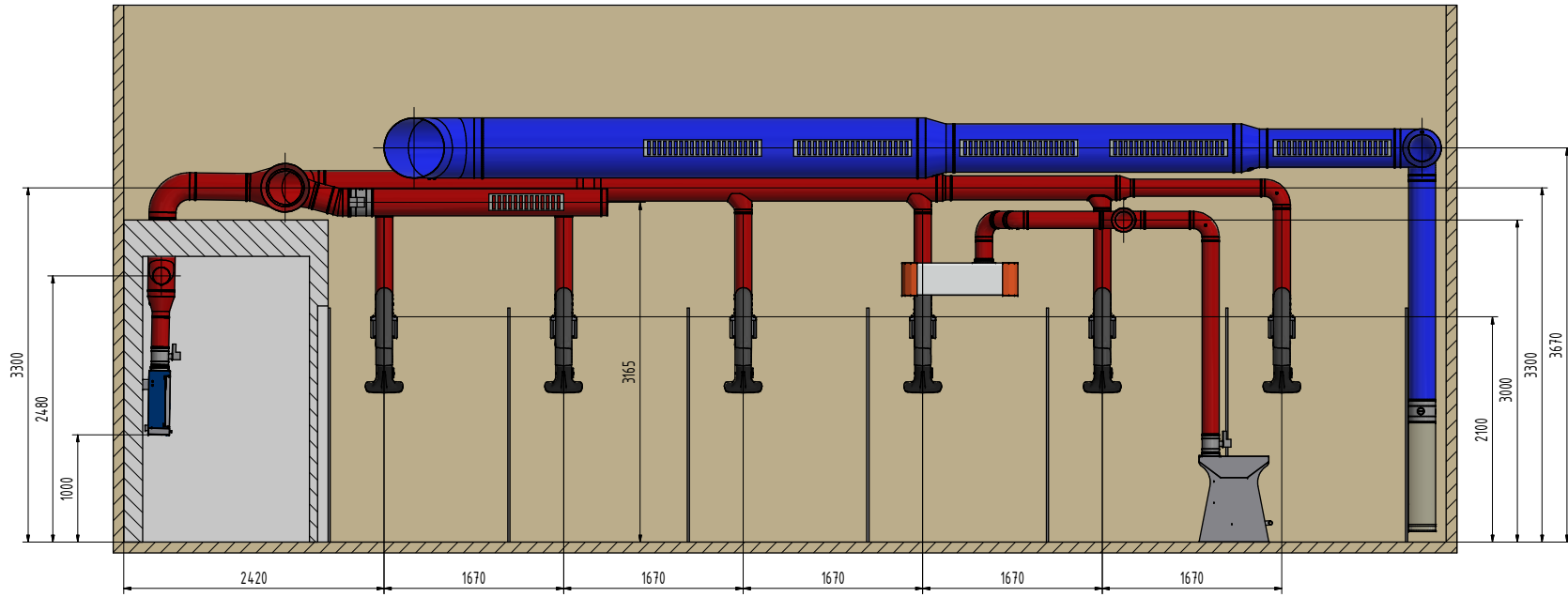

D-D (1 : 33)

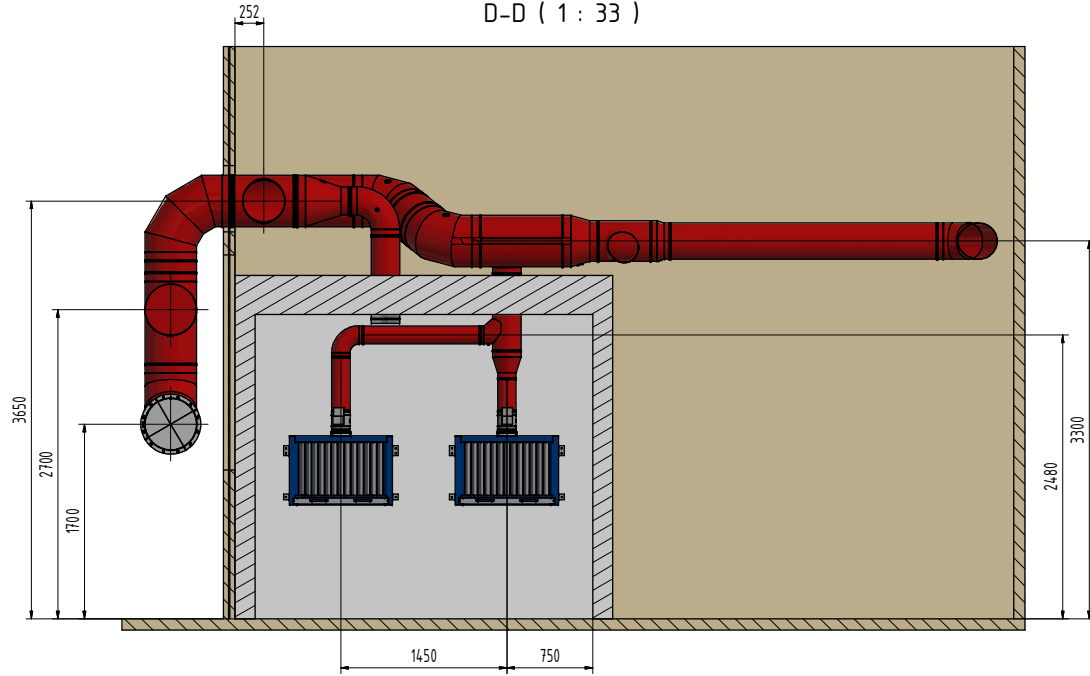

Untoleranced dimensions EN ISO 2768 - mk	Designed by:	grunden	Date	26.04.2022	Item name: Freigabezeichnung Arcelor	
	Drawn by:	grunden	Date	26.04.2022		
Tol. with ISO 8015	 Kemper GmbH · Von-Siemens-Str. 20 · D-48691 Vreden Tel. +49(0)2564/68-0 · Fax +49(0)2564/68-120 www.kemper.eu · mail@kemper.eu				Drawing no:	
Projection: ISO E					Scale:	1 : 33

We retain the copyrights to this drawing and all other parts. It is either not allowed to reproduce the parts or the drawing without our approval or give third parties access. It also may not be misused in any way by the recipient or third party. Protection mark acc. to DIN ISO 16016.

E-E (1 : 33)



Untoeranced dimensions EN ISO 2768 - mk	Designed by:	grunden	Date	26.04.2022	Item name: Freigabezeichnung Arcelor
	Drawn by:	grunden	Date	26.04.2022	
Tol. with ISO 8015	<p style="text-align: center;">KEMPER</p> Kemper GmbH · Von-Siemens-Str. 20 · D-48691 Vreden Tel. +49(0)2564/68-0 · Fax +49(0)2564/68-120 www.kemper.eu · mail@kemper.eu				Drawing no:
Projection: ISO E					520104557_1.1
					Scale: 1 : 33
We retain the copyrights to this drawing and all other parts. It is either not allowed to reproduce the parts or the drawing without our approval or give third parties access. It also may not be misured in any way by the recipient or third partie. Protection mark acc. to DIN ISO 16016.					